

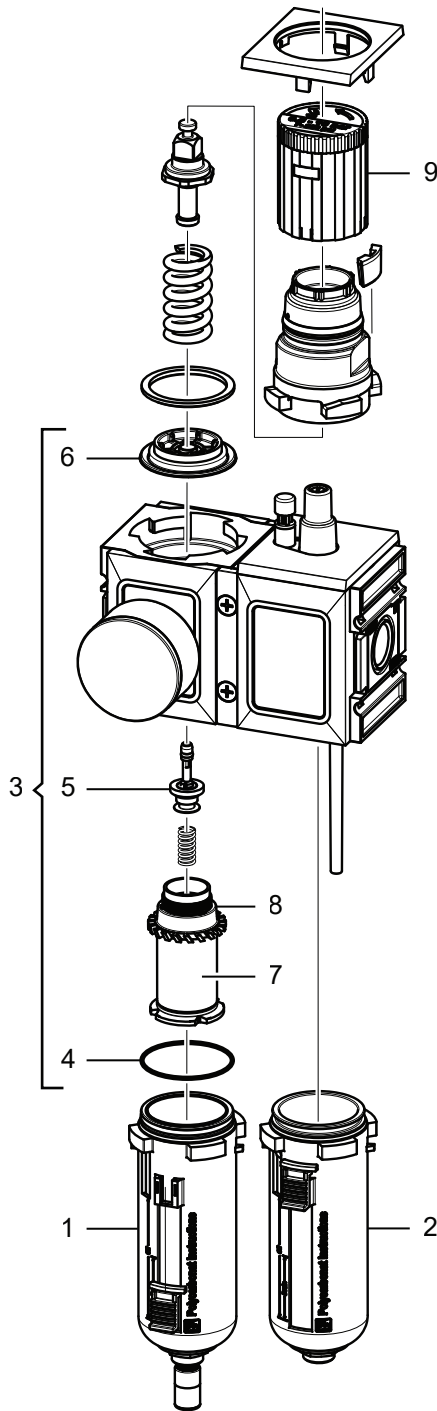





6158135640 (FRL 1/2" BSP)

6158135670 (FRL 1/2" NPT)



Part No.	Description		Q'ty
6154500925	Pressure gauge		1
6154500935	Automatic drain		1
6154500945	Coupling kit		1
6154500965	Coupling kit wall mounting		1
6154500985	Bracket kit		1
6158135700	Adapter NPT from BSP 1/2"		1

Part No.	Description	Q'ty
6154501105	FR12BSP FILTER/REGULATOR 1/2" BSP	1
6154501115	F12BSP FILTER 1/2" BSP	1
6154501125	R12BSP REGULATOR 1/2" BSP	1
6154501135	L12BSP LUBRICATOR 1/2" BSP	1

Item No.	Part No.	Description	Q'ty	Compatibility with			
				FR	F	R	L
1	6154501185	PC-Bowl, semi-automatic drain (O-ring included)	1	X	X		
2	6154501195	PC-bowl, lubricator (O-ring included)	1				X
3 (4+5+6)	6154501205	Valve cone, compl.	1	X		X	
4		O-ring (37.5x2.5mm)	1				
5		Valve cone complete	1				
6		Membrane complete	1				
7	6154501245	Filter	1	X	X		
8	6154501255	Filter bracket and twist plate	1	X	X		
9	6154501265	Handwheel	1	X		X	

	6159990160	Safety information
	6159990240	Product information