



CP3249-GABSYG / CP3249-GABSUD

Part no : 6159945110
 Issue no : 01
 Seris no : C
 Date : 06/2012
 Page : 1 / 6

	Governor spring / Ressort de régulateur Mueller de regulador / Feder des Reglers				
CP3249-GABSYG	6 000 rpm	Orange	Orange	Naranja	Orange
CP3249-GABSUD	4 500 rpm	Purple	Violet	Violeta	Veilichenblau

	CP324. (mm)	CP323. (mm)
H maxi	23	19.9
H mini	21	17.9

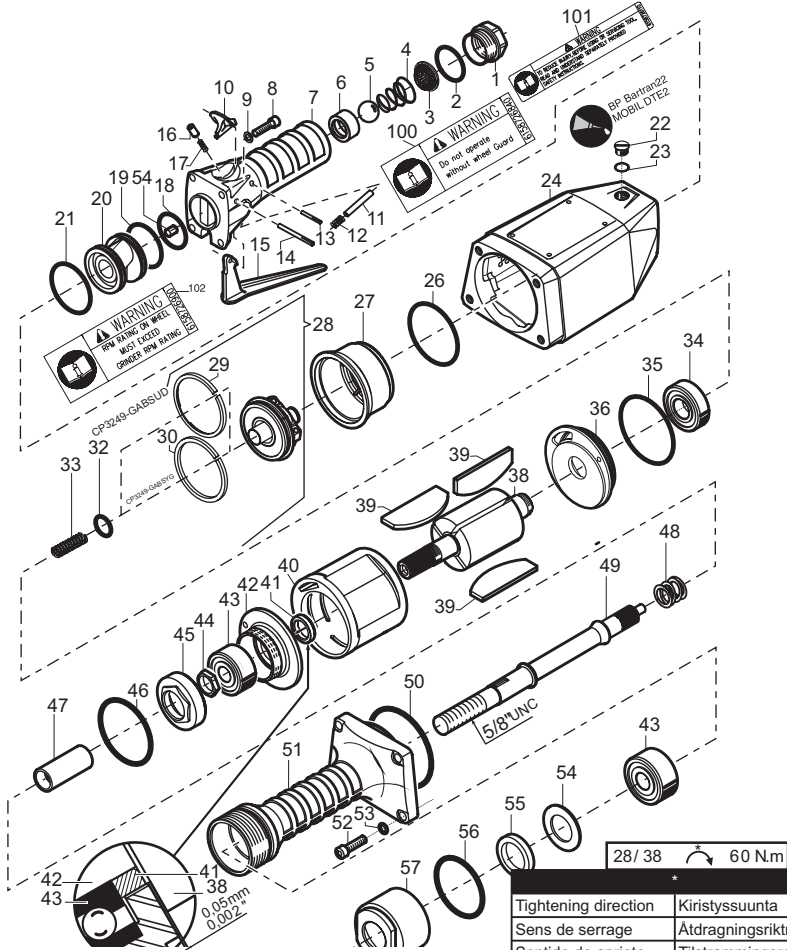

	CP3249-GABSYG	CP3249-GABSUD
rpm	6 000	4 500
W (hp)	3.62 (2 700)	3.22 (2 400)

Tightening direction	Kiristysuunta
Sens de serrage	Åtdragningsriktning
Sentido de apriete	Tilstrammingsretning
Anziehrichtung	Tilspændingsretning
Senso di serraggio	Schroefrichting
Sentido de aperto	Φορά σύσφιξης

Part no : 6159945110
 Issue no : 01
 Seris no : C
 Date : 06/2012
 Page : 2 / 6

CP3249-GABSYG / CP3249-GABSUD

Item Rep	New part no Réf. standard	Qty Qté	Specifics parts Pièces spécifiques	Description	Désignation
1	730.132	1		Adapter	Bague
2	6156581150	1		O ring	Joint torique
3	744.08	1		Strainer	Tamis
4	6156810200	1		Spring	Ressort
5	6157700190	1		Ball	Bille
6	6153210800	1		Seat	Siège de bille
7	315.30	4		Throttle handle	Corps de robinet
8	616.99	4		Screw	Vis
9	645.35	1		Washer	Rondelle
10	6153210820	1		Latch lever	Verrou
11	790.12	1		Pin	Aiguille
12	6156810190	1		Spring	Ressort
13	638.06	1		Roll pin	Goupille
14	6156380050	1		Roll pin	Goupille
15	6156380830	1		Safety lever	Levier
16	321.81	1		Cover	Coiffe
17	681.18	1		Spring	Ressort
18	658.107	1		O ring	Joint torique
19	658.112	1		O ring	Joint torique
20	321.72	1		Oil tank	Réservoir d'huile
21	658.130	1		O ring	Joint torique
22	614.02	1		Screw	Vis
23	650.16	1		Gasket	Joint
24	6153962780	1		Motor Housing	Carter Turbine
26	658.118	1		O ring	Joint torique
27	6153211830	1		Governor housing	Boîtier de régulation
28	6154570340	1	CP3249-GABSUD	Governor 4.5K (29)	Régulateur 4,5K (29)
28	6154570320	1	CP3249-GABSYG	Governor 6K (30)	Régulateur 6K (30)
29	6153201300	1	CP3249-GABSUD	Ring overspeed 4.5K	Anneau de survitesse
30	6153201280	1	CP3249-GABSYG	Ring overspeed 6K	Anneau de survitesse
32	658.120	1		O ring	Joint torique
33	6156811040	1	CP3249-GABSYG	Spring of governor 6K	Ressort de régulateur

CP3249-GABSYG / CP3249-GABSUD

Part no : 6159945110
Issue no : 01
Seris no : C
Date : 06/2012
Page : 3 / 6

Item	New part no	Qty	Specifics parts	Description	Désignation
Rep	Réf. standard	Qté	Pièces spécifiques		
33	6156811030	1	CP3249-GABSUD	Spring of governor 4.5K	<i>Ressort de régulateur</i>
34	758.17	1		Ball bearing	<i>Roulement</i>
35	658.124	1		O ring	<i>Joint torique</i>
36	6154221490	1		Rear plate-end	<i>Joue AR</i>
38	426.68	1		Rotor	<i>Rotor</i>
39	434.48	3		Vane	<i>Palette</i>
40	400.120	1		Liner	<i>Cylindre</i>
41	661.75	1		Collar rotor	<i>Bague de joue</i>
42	420.119	1		Front end plate (41)	<i>Joue AV (41)</i>
43	754.17	2		Ball bearing	<i>Roulement</i>
44	607.49	1		Nut	<i>Ecrou</i>
45	673.68	1		Plug	<i>Bouchon</i>
46	657.32	1		O ring	<i>Joint torique</i>
47	575.84	1		Coupling sleeve	<i>Manchon d'accouplement</i>
48	680.99	1		Spring	<i>Ressort</i>
49	501.36	1		Shaft	<i>Arbre porte-meule</i>
50	658.116	1		O ring	<i>Joint torique</i>
51	552.19	1		Handle	<i>Poignée AV</i>
52	223133	4		Screw	<i>Vis</i>
53	640.06	4		Washer	<i>Rondelle</i>
54	643.54	1		Washer	<i>Rondelle</i>
55	654.05	1		Felt	<i>Feutre</i>
56	658.113	1		O ring	<i>Joint torique</i>
57	673.69	1	CP3249-GABSYG	Plug	<i>Bouchon AV fileté</i>
57	673.70	1	CP3249-GABSUD	Plug	<i>Bouchon AV fileté</i>
58	675.06	1		Oiler	<i>Graisseur</i>
100	6158726840	1		Warning guard label	<i>Etiquette protecteur</i>
101	6158726110	1		Warning instruction	<i>Etiquette instructions</i>
102	6158726900	1		Warning wheel speed label	<i>Etiquette vitesse meuleuse</i>

Part no : 6159945110
 Issue no : 01
 Seris no : C
 Date : 06/2012
 Page : 4 / 6

CP3249-GABSYG / CP3249-GABSUD

Accessories included
Mitgeliefertes Zubehör
Varusteet
Leveret tilbehør

Accessoires livrés
Accessori forniti
Levererade tillbehör
Geleverde accessoires

Accesorios suministrados
Accessórios fornecidos
Tilbehør som følger med
Παρεχόμενα εξαρτήματα



Item Rep	New part no Réf. standard	Qty Qté	Description	Désignation
60	6157040140	1	1/2" air hose nipple for 5/8" ID hose	Busette 1/2" pour tuyau Ø int. 60 15 mm

Ø8" (Ø220mm) For straight grinding wheel / Pour meuleuse droite

CP3249-GABSUD

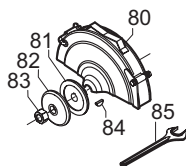

Item Rep	New part no Réf. standard	Qty Qté	Description	Désignation
80	6155040780	1	Wheel guard 8"	Protecteur
81	6155030040	1	Rear flange	Flasque AR
82	6155020070	1	Front flange	Flasque AV
83	6156080060	1	Nut	Ecrou
84	6156300190		Woodruff key	Clavette
85	6158010770		Flat wrench 1-1/16"	Clé plate de 27 mm

CP3249-GABSYG / CP3249-GABSUD

Part no : 6159945110
 Issue no : 01
 Seris no : C
 Date : 06/2012
 Page : 5 / 6

Accessories included
Mitgeliefertes Zubehör
Varusteet
Leveret tilbehør

Accessoires livrés
Accessori forniti
Levererade tillbehör
Geleverde accessoires

Accesorios suministrados
Accessórios fornecidos
Tilbehør som følger med
Παρεχόμενα εξαρτήματα

Ø6-5/8" (Ø165mm) Flap wheel assembly / *Montage roue à lamelles*

CP3249-GABSYG

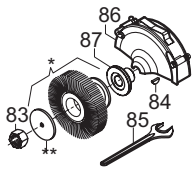

Item Rep	New part no Réf. standard	Qty Qté	Description	Désignation
86	6155040790	1	Wheel guard	Protecteur
87	6155030280	1	Rear flange	Flasque AR
83	6156080060	1	Nut	Ecrou
84	6156300190	1	Woodruff key	Clavette
85	6158010770	1	Flat wrench 1-1/16"	Clé plate de 27 mm
*			Accessory not supplied	Accessoire non fourni

Flange supplied with flap wheel. To be drilled to fit the diameter of the output shaft of the tool.
Flasque livré avec la roue à lamelles. À percer au diamètre de l'arbre de sortie de la machine.

Ø6" (Ø150mm) For straight grinding wheel / *Pour meuleuse droite*

CP3249-GABSYG

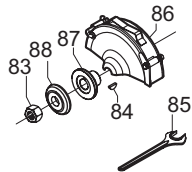

Item Rep	New part no Réf. standard	Qty Qté	Description	Désignation
86	6155040790	1	Wheel guard	Protecteur
87	6155030280	1	Rear flange	Flasque AR
88	6155020270	1	Front flange	Flasque AV
83	6156080060	1	Nut	Ecrou
84	6156300190	1	Woodruff key	Clavette
85	6158010770	1	Flat wrench 1-1/16"	Clé plate de 27 mm

Ø6" (Ø150mm) For straight grinding wheel / *Pour meuleuse droite*

CP3249-GABSYG

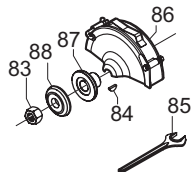

Item Rep	New part no Réf. standard	Qty Qté	Description	Désignation
86	6155040790	1	Wheel guard	Protecteur
87	6155030280	1	Rear flange	Flasque AR
88	6155020270	1	Front flange	Flasque AV
83	6156080060	1	Nut	Ecrou
84	6156300190	1	Woodruff key	Clavette
85	6158010770	1	Flat wrench 1-1/16"	Clé plate de 27 mm

Part no : 6159945110
 Issue no : 01
 Seris no : C
 Date : 06/2012
 Page : 6 / 6

CP3249-GABSYG / CP3249-GABSUD

Accessories included
Mitgeliefertes Zubehör
Varusteet
Leveret tilbehør

Accessoires livrés
Accessori forniti
Levererade tillbehör
Geleverde accessoires

Accesorios suministrados
Accessórios fornecidos
Tilbehør som følger med
Παρεχόμενα εξαρτήματα

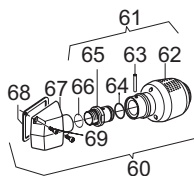

Item Rep	New part no Réf. standard	Qty Qté	Description	Désignation
60	6153994600	1	Complete silencer kit	Kit silencieux complet
61	399.463	1	Complete silencer	Silencieux complet
62	399.736	1	Silencer	Silencieux
63	637.50	1	Roll pin	Goupille
64	658.164	1	O ring	Joint torique
65	730.172	1	Adapter	Bague de raccordement
66	658.246	1	O ring	Joint torique
67	570.338	1	Collector	Collecteur
68	656.57	1	Gasket	Joint papier
69	616.66	2	Screw	Vis

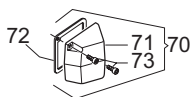

Item Rep	New part no Réf. standard	Qty Qté	Description	Désignation
70	615 399227 0	1	Complete silencer kit	Kit silencieux complet
71	570.159	1	Silencer	Silencieux
72	656.57	1	Gasket	Joint papier
73	616.66	2	Screw	Vis