

**Assembly instructions**

Item #	Tightening torque	Dir.	Glue
01-18	7.5 ft.lb - 10 Nm	↻	Loctite™ 222
29-30	7.5 ft.lb - 10 Nm	↻	Loctite™ 222
29-40	7.5 ft.lb - 10 Nm	↻	
24-36	11 ft.lb - 15 Nm	↻	Loctite™ 222
1-23-24	26 ft.lb - 35 Nm	↻↻	Loctite™ 222

Index No	Part Ref	Description	Qty
<b>A</b>	<b>6154600400</b>	<b>Regulator Assembly</b>	
3		Regulator	1
4		O-Ring 8.1x1.6	1
5		O-Ring 8x1	1
6		Spring Ring Wr9	1
7		Valve Stem	1
8		O-Ring 2x1	1
<b>B</b>	<b>2050546343</b>	<b>Valve Kit</b>	
9		Tip Valve	1
10		Spring	1
<b>C</b>	<b>2050547893</b>	<b>Front Plate Assembly</b>	
25		Front Plate	1
26		Pin Spring 3x4	1
27	6157580520	Bearing 10x26x8	1
28		Washer	1
<b>D</b>	<b>2050547933</b>	<b>Rear Plate Assembly</b>	
26		Pin Spring 3x4	1
33		Rear Plate	1
34	6157581380	Bearing 8x22x7	1
<b>E</b>	<b>2050547943</b>	<b>Motor Assembly</b>	
<b>C</b>	<b>2050547893</b>	<b>Front Plate Assembly</b>	<b>1</b>
<b>D</b>	<b>2050547933</b>	<b>Rear Plate Assembly</b>	<b>1</b>
29	6154261240	Rotor	1
31	2050547803	Blades (Set of 4)	1
32	6154001510	Cylinder	1

Index No	Part Ref	Description	Qty
<b>F</b>	<b>2050546413</b>	<b>Small Parts Kit</b>	
6		Spring Ring Wr9	1
8		O-Ring 2x1	1
12		O-Ring 27x2	1
14		Needle 2.5x11.8	1
17		O-Ring 17x2	1
21		O-Ring 10.5x1.5	1
37		Ring	1
38		Spacer	1
39		O-Ring 15.6x1.78	1
<b>G</b>	<b>2050547923</b>	<b>Tune-Up Kit</b>	
2		Seal	1
16		Felt	1
22		Gaskets (set of 2)	1
31	2050547803	Blades (Set of 4)	1
<b>Other Parts</b>			
1	2050547773	Handle Assy (Incl. Part # 15)	1
11	6155740650	Air Control Ring	1
13	2050541493	Safety Lever	1
15		Rear Cap	1
18	2050542533	Inlet Assy	1
19	6153212410	Insert	1
20	6156561900	Rubber Gasket	1
23	6157301890	Nut	1
24	6155653230	Motor Housing	1
30	6156080510	Rotor Nut	1
35	2050553603	Front Ring	1
36	6156733513	Cover	1
40	6159901850	Wheel	1
	2050500263	4Mm Hex. Wrench (Not Shown)	1

	6158727980	Warning Label
	6159948770	Safety instructions
	2050552743	Operator's manual





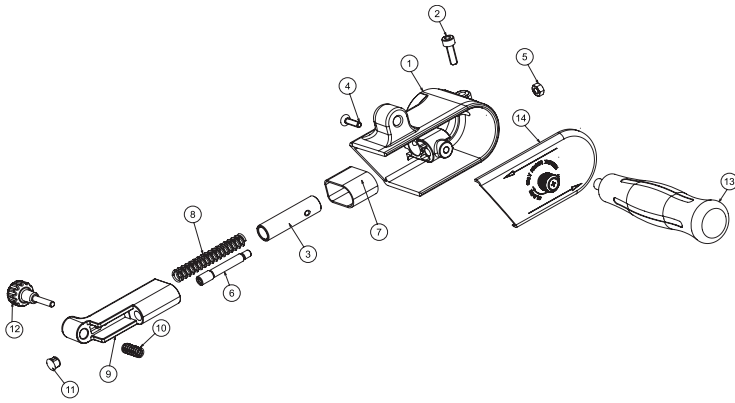

Contact us at [www.cp.com](http://www.cp.com).

Spare parts without part number are not sold separately. High wear parts are underlined.



Index No	Part Ref	Description	Qty
<b>H</b>	<b>2050547953</b>	<b>Guard Support 18" W/ Handle</b>	
1		Guard Support	1
2		Screw	1
4		Screw	1
5		Hex Nut	1
6		Guide Post	1
7		Dust Cover	1
8		Spring	1
9		Arm	1
10		Spring	1
11		Plug	1
12		Knob	1
13		Handle	1
14	2050545823	Cover assembly	1
<b>I</b>	<b>2050546323</b>	<b>Small parts kit 12" Guard</b>	
		<b>Include 2, 4, 5, 6, 7, 8, 10, 11, 12</b>	

**Recommended accessories**

Pics	Part Ref	Description	Qty
	<b>2050545453</b>	<b>Contact Arm 5/8" To 3/4"x 18" (16 to 19 x 457 mm)</b>	
	2050546433	Wheel Assy 5/8" (16 mm)	1
	2050546263	Platten Pad (Set of 10) (1/2" x 1.97" - 19,5x54mm) - Use Loctite™ 411 Or Equivalent	1
	<b>2050545463</b>	<b>Contact Arm 1/2"x18" (13 x 457 mm)</b>	
	2050550273	Wheel Assy 1/2" (13 mm)	1
	2050546233	Platten Pad (Set of 10) (1/16" x 1-15/16" - 17,5x49mm) - Use Loctite™ 411 Or Equivalent	1
	<b>2050545473</b>	<b>Contact Arm 1/8" To 1/2" x 18" (3 to 13 x 457 mm)</b>	
	2050546473	Wheel Assy 1/8" (3 mm)	1
	<b>2050545483</b>	<b>Contact Arm 1/2"x 18" (13 x 457 mm)</b>	
	2050546483	Wheel Assy 1/2" (13 mm)	1
	2050546283	Platten Pad (Set of 10) (1/2" x 2-1/8" - 12,5x54mm) - Use Loctite™ 411 Or Equivalent	1
	<b>2050545493</b>	<b>Contact Arm 1/4"x18" (6 x 457 mm)</b>	
	2050546493	Wheel Assy 1/4" (6 mm)	1
	2050546253	Platten Pad (Set of 10) (5/16" x 2.05" - 7,5x52mm) - Use Loctite™ 411 Or Equivalent	1
	<b>2050545503</b>	<b>Contact Arm 1"x18" (25 x 457 mm)</b>	
	2050546423	Wheel Assy 1"(25 mm)	1
	2050546293	Platten Pad (Set of 10) (26x55mm) - Use Loctite™ 411 Or Equivalent	1